

GYMSTICK™

ALPHA WEIGHT BENCH USER MANUAL



IMPORTANT: Read all instructions carefully before using this product. Retain this owner's manual for future reference. The specifications of this product may vary from this photo, subject to change without notice.



GYMSTICK.COM

BEFORE YOU BEGIN	2	ASSEMBLY INSTRUCTION	4
SAFETY INSTRUCTIONS	2	IMPLIED WARRANTY	7
ASSEMBLY PARTS	3		

BEFORE YOU BEGIN

Thank you for choosing the Gymstick Alpha Weight Bench. We take great pride in producing this quality product and hope it will provide many hours of effective exercise to make you feel better, look better and enjoy life to its fullest.

SAFETY INSTRUCTIONS

- Misuse and abuse of this product is dangerous and can cause serious injuries.
- All purchasers and all persons using this device must become familiar with the manufacturer's recommendations for proper assembly, use and care.
- The owner and supervisors of this product are responsible to make all users aware of these Safety Instructions.
- Place the device on a level and dry surface before use.
- Inspect your the product before each use. Replace any worn, defective, or missing parts.
- This product is not a toy. Do not allow children to use this product. Keep small children and pets away from the product at all times (including assembly).
- Place this device away from walls, structures, fences, play areas, furniture and other exercise equipment. Maintain a clear space on all sides of the product.
- This product should always be used by only one person at a time.
- Always store the product indoors in a dry place.
- For maintenance and cleaning. Please clean the dirt with detergent scour, using dry rag and clean water (do not use gas, dilution or other chemicals).
- The maximum weight load is 300kg.













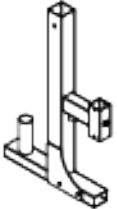
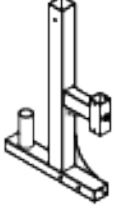
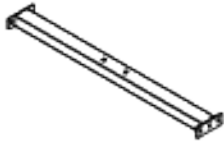
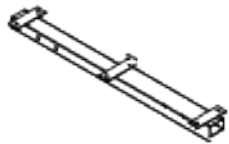

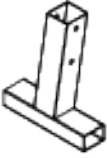

NOTIFICATION!

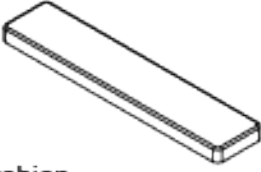
Before starting any exercise or conditioning program you should consult with your personal physician to see if you require a complete physical exam. This is especially important if you are over the age of 35, have never exercised before, are pregnant, or suffer from any illness.



WARNING!

READ AND FOLLOW THE SAFETY INSTRUCTIONS. FAILURE TO FOLLOW THESE INSTRUCTIONS CAN RESULT IN SERIOUS INJURY.

<p>1</p>  <p>Right upright frame 1 PC</p>	<p>2</p>  <p>Left upright frame 1 PC</p>	<p>3</p>  <p>Crossing frame 1 PC</p>	<p>4</p>  <p>Main frame 1 PC</p>
<p>5</p>  <p>Rear stabilizer frame 1 PC</p>	<p>6</p>  <p>Front stabilizer frame 1 PC</p>	<p>7</p>  <p>Rear adjustable frame 2 PCS</p>	<p>8</p>  <p>Front adjustable frame 2 PCS</p>
<p>9</p>  <p>Connection plate 4 PCS</p>	<p>10</p>  <p>Cushion 1 PC</p>	<p>11</p>  <p>Knob 4 PCS</p>	<p>12</p>  <p>Outside end cap 6 PCS</p>
<p>13</p> <p>M12*100mm hex bolt</p>  <p>12 PCS</p>	<p>14</p> <p>M12*70mm bolt</p>  <p>2 PCS</p>	<p>15</p> <p>M8*20 hex bolt</p>  <p>6 PCS</p>	<p>16</p> <p>M12 washer</p>  <p>26 PCS</p>
<p>17</p> <p>M8 washer</p>  <p>6 PCS</p>	<p>18</p> <p>M12 locknut</p>  <p>14 PCS</p>		

STEP 1

- 1) Put the outside end cap (12) onto the left & right upright frame (1&2).
- 2) Put the knob (11) onto the left & right upright frame (1&2).
- 3) Attach the rear stabilizer frame (5) to the crossing frame (3) using M12 X 70mm bolt (14) and M12 washer (16) & M12 locknut (18).
- 4) Attach the right & left upright frame (1&2) to the crossing frame (3) using M12 X 100 hex bolt (13) and M12 washer (16) & M12 locknut (18).

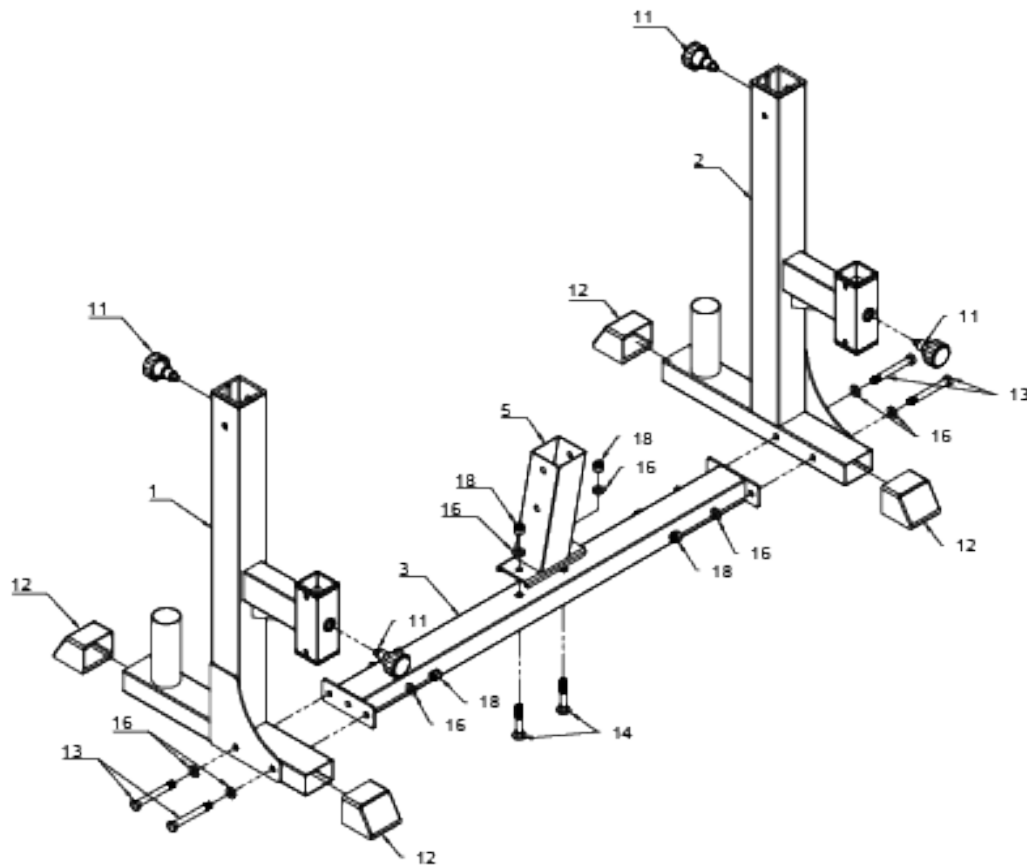

NOTE! There is a slip proof coating in the nut. Please tighten with a wrench.

STEP 2

- 1).Put the outside end cap(12) onto the front stabilizer frame(6).
- 2).Attach the front stabilizer frame(6) to the main frame(4) using the connection plate(9) and hex bolt M12 X 100mm(13),M12 washer(16)& M12 locknut(18).
- 3).Attach the rear frame(5) to the main frame(4) using the connection plate(9) and hex bolt M12 X 100mm(13),M12 washer(16)& M12 locknut(18).

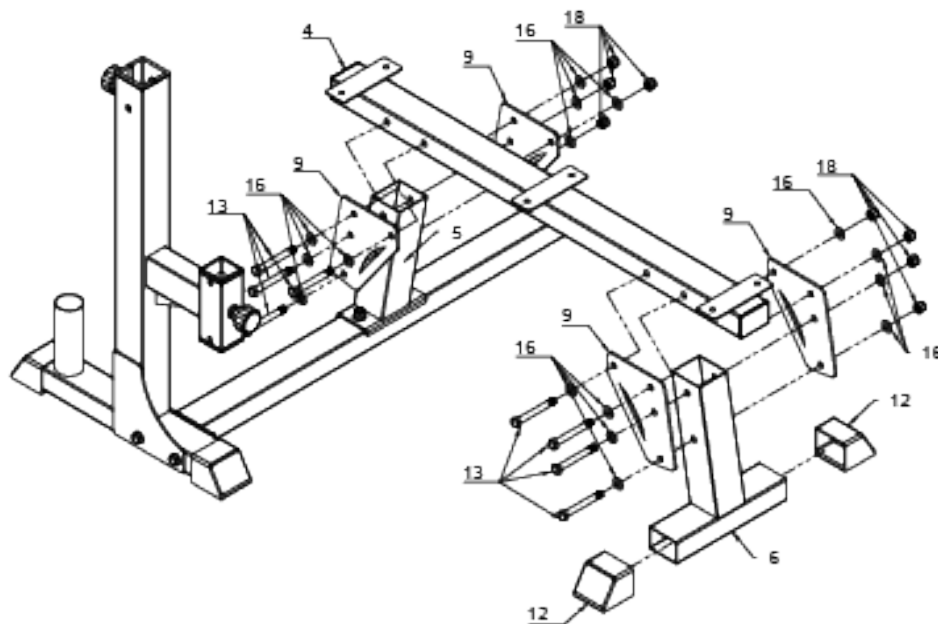

NOTE! There is a slip proof coating in the nut. Please tighten with a wrench.

STEP 3

- 1) Slide the rear adjustable frame (7) into the right & left upright frame (1&2) using knob(11).
- 2) Slide the front adjustable frame (8) into the right & left upright frame (1&2) using knob (11).
- 3) Attach the cushion (10) to the main frame (4) using hex bolt M8 X 20mm (15), M8 washer (17).

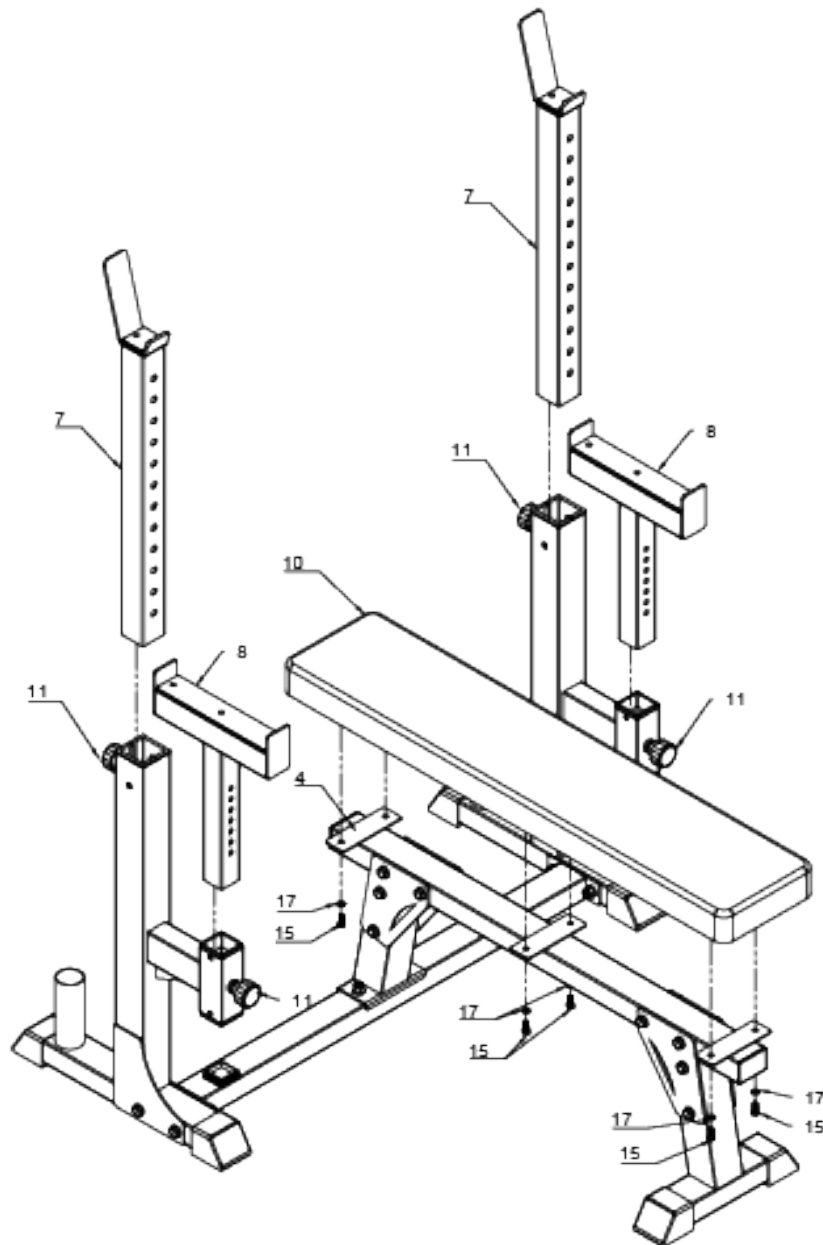

NOTE! There is a slip proof coating in the nut. Please tighten with a wrench.

The importer of this product assures that this device is manufactured with high quality materials.

The prerequisite for the implied warranty is the proper setup in accordance with the operating instructions. Improper use and /or incorrect transportation can void the warranty.

The implied warranty is valid for 3 years, beginning from the date of purchase. For eventual defects please contact the dealer of this product within the guarantee period.

The warranty applies to the following parts (as far as included in the scope of delivery): frame.

The guarantee does not cover:

- Damage effected by outer force
- Intervention by unauthorized parties
- Incorrect handling of the product
- Non-compliance of the operating instructions

Note: Wear parts and expendable parts are also not covered.

Manufactured for:
Gymstick International Oy
Ratavartijankatu 11
15170 Lahti, FINLAND



Devices marked with this symbol must be disposed of separately from your household waste, as they contain valuable materials which can be recycled. Proper disposal protects the environment and human health. Your local authority or retailer can provide information on the matter.

